

Instructions

Edition 10 / 2021

DSM5/DSF5/DSM7 Brushless Servomotors

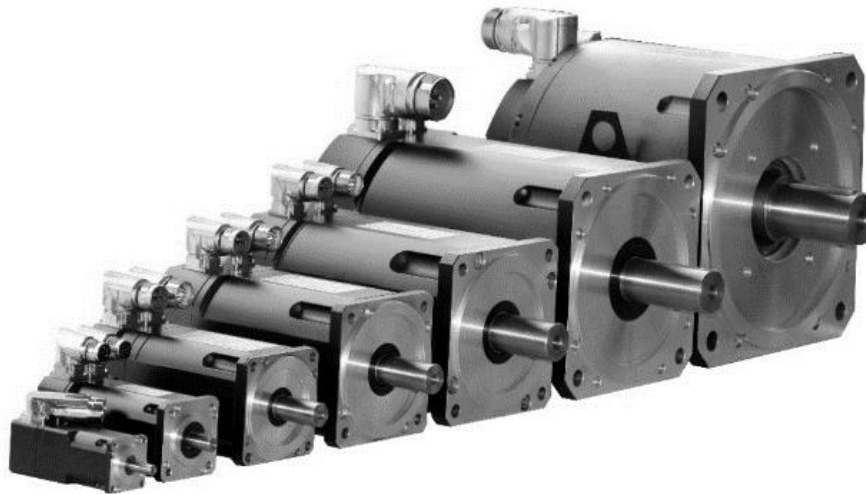

1	General indications	
1.1	About this manual.....	1
1.2	Target group.....	1
1.3	Symbols used.....	1
2	Safety	
2.1	Safety notes.....	1
2.2	Use as directed.....	2
2.3	Prohibited use.....	2
3	Handling	
3.1	Transport.....	3
3.2	Storage.....	3
3.3	Maintenance / Cleaning.....	4
3.4	Repairs.....	4
3.5	Disposal.....	4
4	Mechanical installation	
4.1	Important notes.....	4
5	Electrical installation	
5.1	Safety notes.....	5
5.2	Guide for electrical installation.....	5
5.3	Connection of the motors.....	6
6	Setup	
6.1	Important information.....	6
6.2	Guide for setup.....	6
6.3	Troubleshooting.....	6

1) General indications

1.1 About this manual

This manual contains instructions that must be obeyed for the safety of personnel and to avoid damaging the equipment.

1.2 Target group

This manual is destined to be used by persons with the following qualifications:

Transport: only by specialist personnel trained in the movement of electrostatically sensitive components.

Mechanical installation: only by specialist mechanics.

Electrical installation: only by qualified electricians.





Setup: only by qualified personnel with extensive knowledge of electrical engineering and drive technology.

Technical staff must know and observe the following standards and directives: IEC 60364 and IEC 60664 national accident prevention regulations

▲ WARNING *The operator must ensure that the safety instructions in this manual are followed.*

The operator must ensure that all personnel responsible for working with the motor have read and understood the product manual.

1.3 Symbols used

SYMBOL	DESCRIPTION
	Indicates a hazardous situation which, if not avoided, will result in death or serious injury.
	Indicates a hazardous situation which, if not avoided, could result in death or serious injury.
	Indicates a hazardous situation which, if not avoided, could result in minor or moderate injury.
	Indicates a hazardous situation which, if not avoided, could result in damage to property.
	This is not a safety symbol. It is used to indicate important information.

2) Safety

2.1 Safety notes

▲ WARNING *The person carrying out installation is required to perform risk assessment for the machine and to take appropriate measures to ensure that unforeseen movements will not cause injury or damage to persons or property.*

Make sure that the motor housing is adequately earthed to the reference earth busbar. No electrical safety can be guaranteed for persons without a low-resistance earth connection.

Do not unplug any of the connectors during operation. This creates a danger of death, severe injury, or extensive material damage.

Power connections may be live even when the motor is not turning. Never unfasten the motor power connections while the equipment is under power. In unfavourable situations this can cause flashovers, with resulting injuries to persons and damage to property.

After disconnecting the servomotors from the supply voltage, wait several minutes before touching any components which are normally live (e-g- contacts, screw connections) or opening any connections. To be quite safe, measure the voltage in the intermediate circuit and wait until the voltage has fallen below 40V.



The surfaces of the motors can be very hot during operation, according to their protection category. The surface temperature can exceed 100°C. Measure the temperature, and wait until the motor has cooled down to below 40°C before touching it.

Remove any key (if present) from the shaft or fasten it if the motor is running independently, to avoid the danger of injury due to the key being thrown out by centrifugal force.

Built-in holding brakes do not guarantee the safety of personnel! Hanging loads (vertical axes) require an additional, external mechanical brake to guarantee the safety of personnel.

Repairs must only be carried out by the manufacturer or by authorised repair workshops. Unauthorised opening and poorly performed repairs may result in injury or material damage, and will invalidate the warranty. Before starting up motors that have a tongue at the end of the shaft, this element must be fastened to ensure it does not come out, if this cannot be prevented by drive elements such as pulleys, joints or the like.

▲ CAUTION *Only properly qualified personnel are permitted to perform such tasks as transport, assembly, setup and maintenance. Properly qualified personnel are persons who are familiar with the transport, assembly, installation, setup and operation of motors, and who have the appropriate qualifications for their jobs. Qualified personnel must know and observe the following standards and regulations: IEC 60364 or IEC 60664, National safety/accident prevention regulations.*

Always use suitable lifting equipment to lift and move motors weighing more than 20 Kg. Lifting the motors without assistance could result in back injury.

Read this documentation before assembly and setup. Incorrect handling of the motor can result in injury and damage to persons and property. Always comply with the technical data and the information on connection requirements (rating plate and documentation).

The motors are not designed to be connected directly to the three phase power supply, but must be operated using an electronic frequency converter. Direct connection to the mains can cause damage to the motor.

The thermal probe integrated in the winding to protect the motor from slow thermal overloading must be connected and checked by means of a suitable command.

In motors fitted with a brake, check for the presence of a varistor on the brake power circuit before starting up.

2.2 Use as directed

- The **DSM5/DSF5/DSM7** series of synchronous servomotors is designed specifically as drives for industrial robots, machine tools, textile and packing machinery and other similar devices with high dynamic requirements.
- Only operate the motors under the conditions defined in this documentation.
- The **DSM5/DSF5/DSM7** motors must not be operated in environments with caustic acids and bases.
- The **DSM5/DSF5/DSM7** motors must not be used in applications involving direct contact with food and beverages.
- The motors are installed as components in electrical apparatus or machines and can only be commissioned and put into operation as integral components of such apparatus or machines.
- The thermal safety contact integrated in the motor windings must be analysed and monitored.
- The holding brakes are designed as standstill brakes and are not suited for repeated operational braking.
- The conformity of the servo-system to the standards mentioned in the EC Declaration of Conformity is only guaranteed if original components are used and the conditions set down in this manual are complied with.

2.3 Prohibited use

- Use of **DSM5/DSF5/DSM7** motors is not allowed:
 - directly on mains supply networks,
 - in areas where there is a risk of explosions,
 - in contact with food and beverages,
 - in environments with acids or base solutions with a pH value below 2 or above 12.
 - In environments with acids or base solutions
- Commissioning the motor is prohibited if the machine in which it is installed:
 - does not meet the requirements of the EC Machinery Directive,
 - does not comply with the Electromagnetic Compatibility Directive,
 - does not comply with the Low Voltage Directive.
- To guarantee the safety of personnel, the holding brakes must not be used without further equipment.

3) Handling

3.1 Transport

- Transport temperature: -25 to +70°C, maximum variation 20K/hour. Atmospheric humidity during transport: relative humidity 5% - 95%, no condensation.
- Only by qualified personnel.
- Use the manufacturer's original recyclable packaging.
- Avoid impact, in particular on the shaft end.
- If the packaging is damaged, check that there is no visible damage to the motor. Inform the carrier and, if necessary, the manufacturer.

Lifting eyes must be used to transport DSM5/DSF5/DSM7 motors (>20 kg.) in safety.

▲ DANGER *Never stand under the load during the lifting procedure.*



- **The lifting eye fastening screws must be fully locked.**
- **The lifting eyes must be positioned on the supporting surface in an even, flat manner.**
- **Prior to use, check that the lifting eyes (if present) are properly fitted and show no obvious damage (corrosion, deformation).**
- **Lifting eyes with any signs of deformation must not be used.**



3.2 Storage

- Climate category 1K4 according to EN 61800-2
- Storage temperature: 0 to +55°C, maximum variation 20K/hour.
- Atmospheric humidity: relative humidity 5% - 95%, no condensation.
- Store in the manufacturer's original recyclable packaging.
- See the packaging table for the maximum stacking height.
- Storage time: 3 years (revision may be required after this period).

3.3 Maintenance/Cleaning

- Only by qualified personnel.
- The ball bearings should be replaced after 20,000 hours of operation under rated conditions.
- Check the motor for bearing noise every 2500 working hours or once a year. If noises are heard, stop using the motor: the bearings must be replaced.
- Opening the motor invalidates the warranty.
- Keep the external housing clean and free from oil, grease or dirt that will prevent proper heat dispersal.
- Periodically check that the connectors and earthing connection are tightly locked.
- If there is a fan, check that the grill is clean and the fan is not noisy.
- If necessary, replace using original spare parts only.
- The motor output cables are designed for fixed laying (cable duct or cable clamp version).
- Check the brake periodically for wear and sealing.
- Check the thermal protection periodically to ensure it is working properly.
- If a rotating shaft sealing ring is fitted, make sure that it is suitably lubricated. Check and replace the sealing ring periodically. The maximum speed of the motor is determined by the presence of the sealing ring.
- Clean with Isopropanol or similar, *do not immerse or spray*.

3.4 Repairs

Repair of the motor must only be carried out by the manufacturer or by authorised workshops. Opening the motor invalidates the warranty.

3.5 Disposal

We do not take old devices and accessories back for professional disposal. Consequently, the devices must be taken to the relevant disposal facilities in line with the regulations in force in the country where the motor is installed.

4) Mechanical installation

INFO

The dimensions of the motors can be found in the preceding paragraphs.

4.1 Important notes

CAUTION Only qualified staff with knowledge of mechanical engineering are permitted to install the motor. Protect the motor from unacceptable stress. Take care, particularly during transport and handling, that components are not bent and that insulation distances are not altered.

The installation site must be free of conductive and aggressive materials. For V3 mounting (shaft end upwards), make sure that no liquids can enter the bearings.

Ensure free ventilation of the motors and observe the permissible ambient and flange temperatures. For ambient temperatures above 40°C please contact our technical department to request derating. Ensure that there is adequate heat transfer in the surroundings and the motor flange, so that the maximum permissible flange temperature is not exceeded in S1 operation.

Servomotors are precision equipment. The flange and shaft are especially vulnerable during storage and assembly - so avoid using brute force. Use the locking thread provided for the drive shaft (see figure) to fasten drive components such as gear wheels or pulley wheels, and warm up the drive components whenever possible. Blows or the use of force will lead to damage to the bearings and the shaft.

If the brake is present, **no axial loads must be used**, to prevent modification of the brake settings.

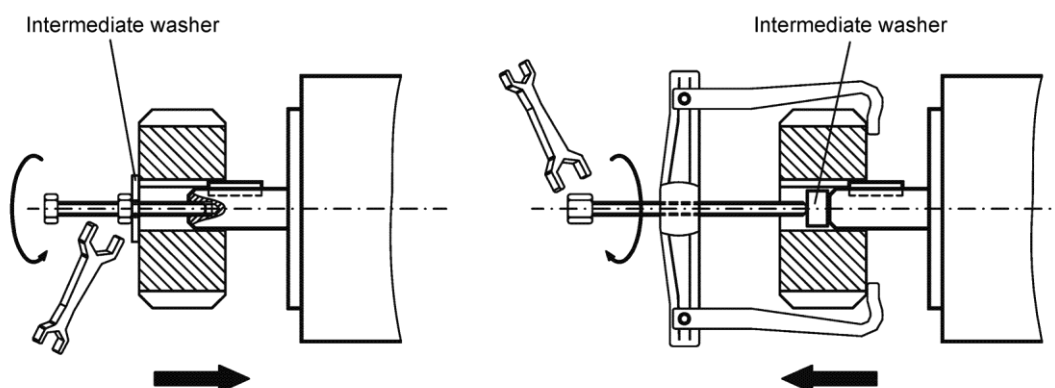

Make sure that the coupling is correctly aligned. Any displacement will cause unacceptable vibration and may result in destruction of the bearings and the coupling itself.

When used with toothed belts or pulleys, observe the permissible radial forces.

An excessive axial load on the shaft will significantly shorten the life of the motor.

Whenever possible, avoid axial stress on the drive shaft. Axial load on the shaft will significantly shorten the life of the motor.

Take note of the number of motor poles and the number of resolver poles, and ensure that the correct number of poles is used when setting up the servo amplifier. An incorrect setting can lead to irreparable damage, particularly in the case of smaller motors.

Check compliance with the permitted radial and axial forces FR and FA.

5) Electrical installation



INFO Wiring diagrams can be found in the instruction manual for the servo amplifiers.

5.1 Safety notes

▲ WARNING *Only qualified staff with training in electrical engineering are permitted to wire the motor.*

Always make sure that the motors are de-energised during assembly and wiring, i.e. no voltage must be switched on in the equipment to be connected. Make sure that the electrical cabinet has been safely turned off (barrier, warning signs, etc.). The individual voltages will only be turned on again during setup.

Never unfasten the motor power connections while the equipment is under power. Dangerous voltages may still be present in the servo amplifier capacitors several minutes after the mains power supply has been switched off. Measure the voltage in the intermediate circuit and wait until the voltage has fallen below 40V. Control and power connections may be live even when the motor is not turning.

INFO The ground symbol  which you will find in the wiring diagrams, indicates that you must provide an electrical connection with as large a surface area as possible between the unit indicated and the mounting plate in the electrical cabinet. This connection is to allow dispersion of high frequency interference, and must not be confused with the  PE (protective earth) symbol (protective measure according to EN 60204). Also follow the notes in the instruction manual wiring diagrams for the servo amplifier used, which requires periodic verification of the state of the grounding system.

5.2 Guide for electrical installation

- Check that the servo amplifier and the motor match each other. Compare the rated voltage and rated current in the units. Carry out the wiring according to the wiring diagram in the servo amplifier instruction manual. The motor connections are indicated in the preceding chapters.
- Check that the feedback installed on the motor is of a suitable type and in line with the drive manufacturer's requirements. In case of doubt, perform laboratory tests.
- Ensure that earthing of the servo amplifier and motor is carried out properly. Make sure that shielding and earthing comply with electromagnetic compatibility requirements. Earth the mounting plate and motor casing.
- If possible, route the power and signal cables separately (separation >20cm). This will improve the immunity of the system to electromagnetic interference. If a motor power cable is used which includes integral brake control leads, then these brake control leads must be shielded. The shielding must be connected at both ends (see the servo amplifier installation manual).
- Cabling
 - If possible, route the power and control cables separately.
 - Connect up the resolver or encoder
 - Connect the motor cables, first to the motor choke (if there is one) then to the servo amplifier.
 - Ground the shielding cables at both ends.
 - Connect the motor holding brake, if there is one.
- All the cables carrying heavy currents must have an adequate cross-section, as per EN60204-1:2006.
- Connect up all shielding via a wide surface-area contact (low impedance) and metallised connector housings or EMC-compatible threaded cable gland.
- Check the quality of earthing periodically.

5.3 Connection of the motors

- Carry out the wiring in accordance with the standards and regulations in force.
- Only use suitable tested shielded cables for the resolver and power connections.
- Connect up the shielding according to the wiring diagrams in the servo amplifier instruction manuals.
- Incorrectly installed shielding inevitably causes electromagnetic disturbance.
- Maximum cable length: follow the indications given in the servo amplifier instruction manuals.

INFO

Please contact the technical department when selecting the cables.

6) Setup

6.1 Important notes

▲ WARNING Only specialist personnel with extensive technical knowledge are allowed to commission the drive unit with servo amplifier/motor.

Check that all live connection points are safe against accidental contact. Deadly voltages of up to 900V can occur.

Never unfasten the motor power connections while the equipment is under power. Dangerous voltages may still be present in the servo amplifier capacitors several minutes after the mains power supply has been switched off.

The surface temperature of the motor can exceed 100°C in operation. Check (measure) the temperature of the motor. Wait until the motor has cooled down to 40°C before touching it.

Make sure that, even if the rive starts to move unintentionally, no danger can result for personnel or machinery.

6.2 Guide for setup

The setup procedure is described as an example. A different method may be appropriate or necessary, depending on the expected use.

- Check the assembly and orientation of the motor.
- Check that the drive components are in their proper housings and have been set correctly (respecting the permissible radial and axial forces).
- Check the wiring and connections to the motor and the servo amplifier. Ensure that earthing has been carried out properly.
- Check that the holding brake, if there is one, is working properly (the brake must release when 24V is applied).
- Check whether the motor rotor can turn freely (first release the brake, if there is one). Listen for grinding noises.
- Check that the required measures against accidental contact with live and moving parts have been taken.
- Carry out any further tests which are specifically required for your system.
- Commission the drive according to the setup instructions for the servo amplifier.
- In multi-axis systems, individually commission each servo amplifier/motor drive unit at minimum performance levels.
- Only perform complete testing after you have ensured that all components and settings are suitable.

6.3 Troubleshooting

The following table is to be seen as a "First Aid" box. There may be a number of possible reasons for a fault, depending on the conditions in the system you are using. The fault causes described below are mostly those relating directly to the motor. Errors in parametrisation of the servo amplifier will cause malfunctions and possibly faults. Please consult the documentation for the servo amplifier and the operating software, and check that the tutor feedback is compatible with the drive requirements.

In interpolating systems the CNC may also be involved in any causes of malfunction.

Our technical department is able to provide any support required.

FAULT	POSSIBLE CAUSE	MEASURES TO ELIMINATE THE FAULT
The motor doesn't turn.	Servo amplifier not enabled. Power cable broken. Motor phases in wrong sequence. Brake not released. Motor is mechanically blocked. Incorrect feedback phasing.	Activate the ENABLE signal. Check the power cable. Correct the phase sequence. Check brake controls. Check the mechanism. Perform automatic drive phasing or contact the supplier.
Motor runs away.	Motor phases in wrong sequence. Transducer is at the wrong angle. Transducer connection reversed.	Set the correct the phase sequence. Check connections.
The motor oscillates.	Break in the signal cable screening. Amplifier gain too high. Rotor/load inertia ratio incorrectly balanced.	Replace the signal cable. Review the current ring settings. Review the kinematic chain (speed/position).
Brake error message.	Short-circuit in the supply voltage line feeding the motor holding brake. Faulty holding brake.	Eliminate the short-circuit. Replace or repair the motor.
Motor power supply error message.	The motor cable is short-circuiting or shorting to earth. The motor is short-circuiting or shorting to earth.	Replace the cable. Replace or repair the motor.
Transducer error message.	Transducer connector not properly plugged in. Transducer cable broken, crushed or incorrect.	Check the connector. Check the cables. Check wiring.
Motor temperature error message.	Motor thermostat has switched. Transducer connector loose or transducer cable broken.	Wait until the motor has cooled down, then check the cause of the overheating (overload). Check the connector and replace the transducer cable if necessary.
Brake does not come on.	Power supply faulty or incorrect. Required holding torque is too high. Faulty brake. Axial overload on motor shaft.	Check dimensioning and power supply. Check the axial load and reduce it. Replace the motor.